

SIMPLY ONE / FILTRA ONE

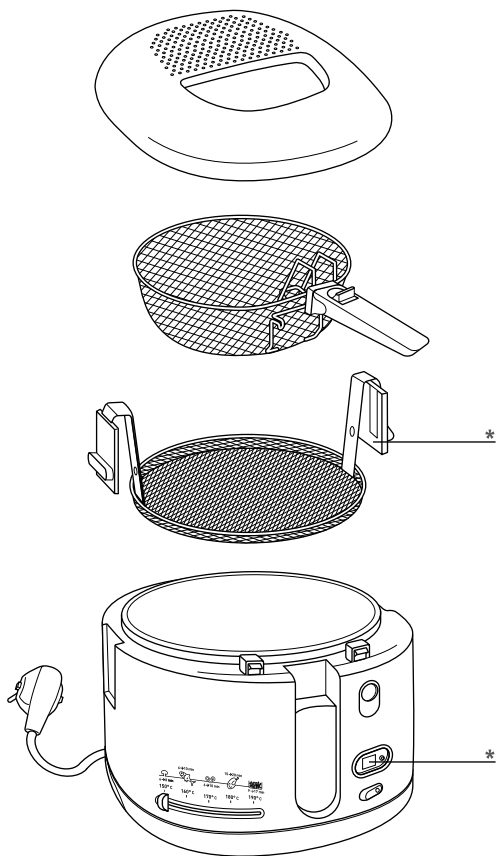



* Selon modèle • Afhankelijk van het model • Je nach Modell • Depending on model • Secondo i modelli • Según modelo • Consoante o modelo • ανάλογα με το μοντέλο • Modelle göre • Afhængig af model • Beroende på modell • Avhenger av modell • Mallista riippuen • Ovisno o modelu • Zavisno od modela • В зависимости от модели • Odvisno od modela • W zależności od typu • Podle modelu • V závislosti od modelu • Modellitöl függően • В зависимости от модели • Залежно від моделі • Ovisno o modelu • Sõltuvalt mudelist • Atbilstoši modelim • Pagal modelį • بحسب الموديل • بر حسب مدل



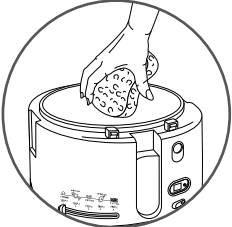
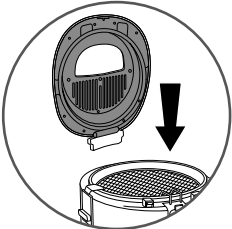
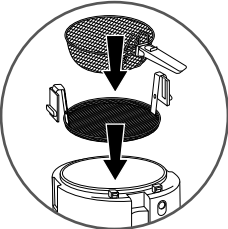
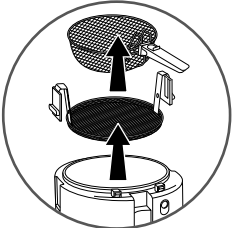
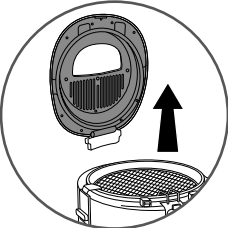
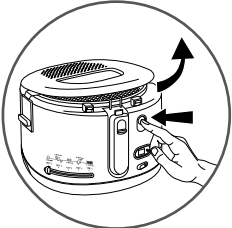



Min. 1,9 l
Max. 2,1 l

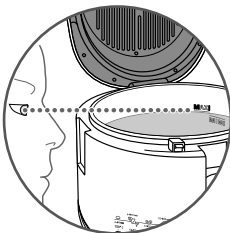
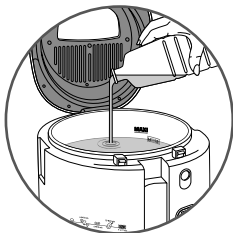

Min. 1660 g
Max. 1910 g

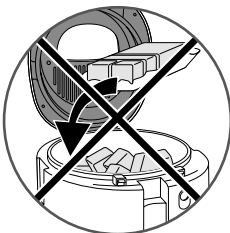
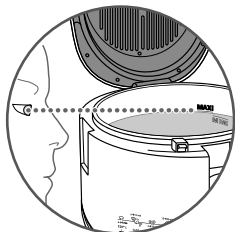
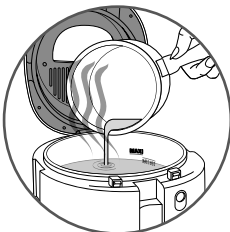
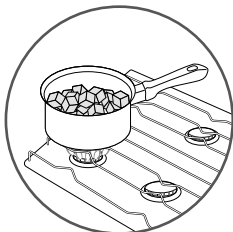

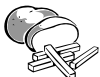

Max. 1200 g

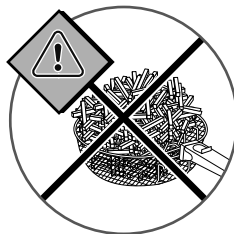
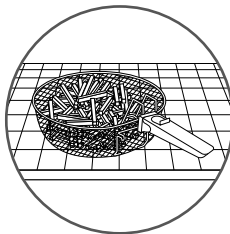
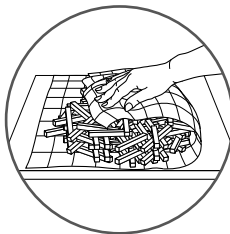

Max. 900 g

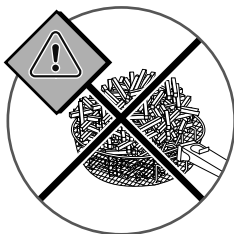
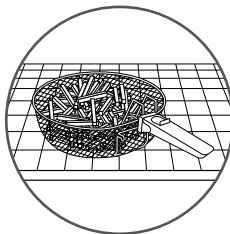
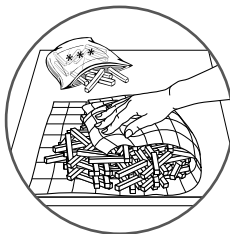

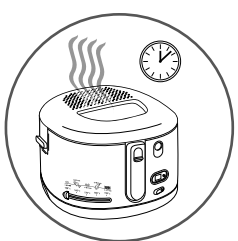
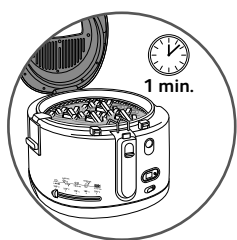
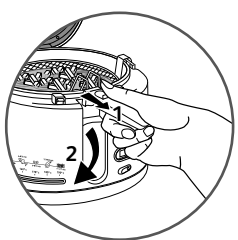
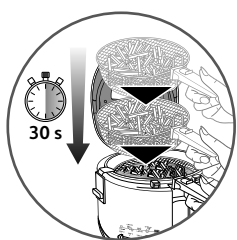
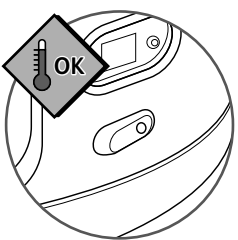
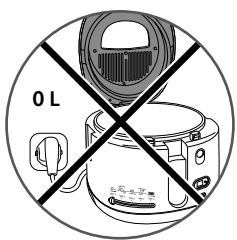
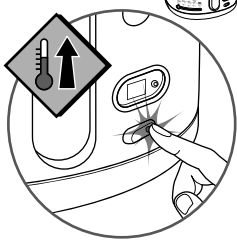
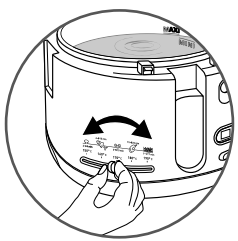
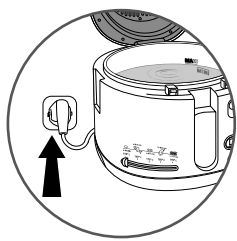

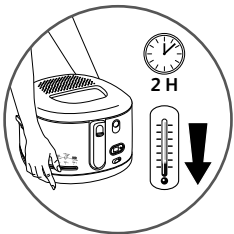
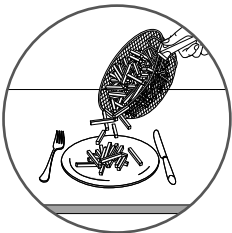
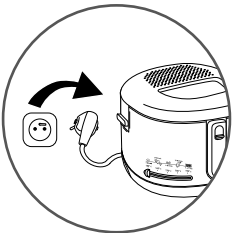
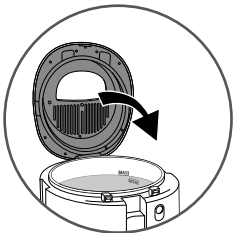
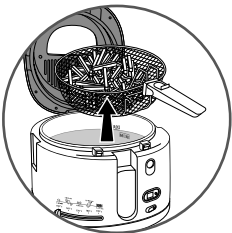
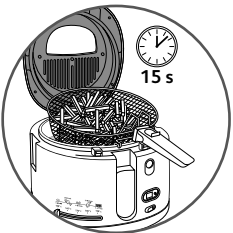
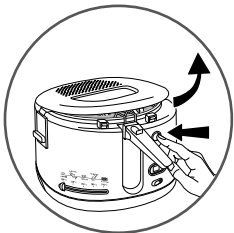
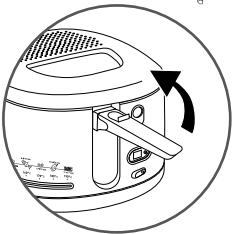
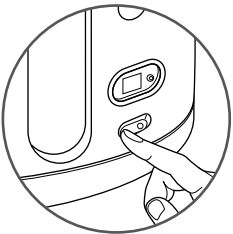
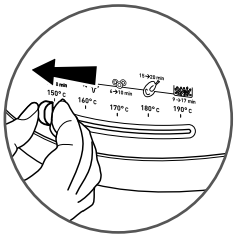

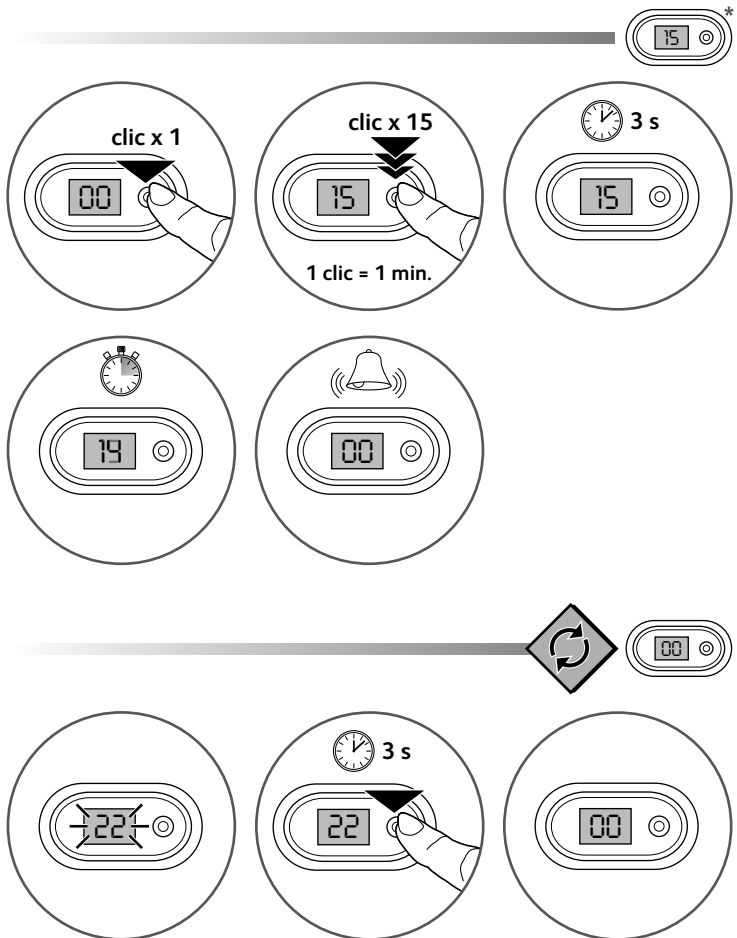

* Selon modèle • Afhankelijk van het model • Je nach Modell • Depending on model • Secondo i modelli • Según modelo • Consoante o modelo • ανάλογα με το μοντέλο • Modele göre • Afhængig af model • Beroende på modell • Avhenger av modell • Mallista riippuen • Ovisno o modelu • Zavisno od modela • В зависимости от модели • Odvisno od modela • W zależności od typu • Podle modelu • V závislosti od modelu • Modelltól függően • В зависимости от модели • Залежно від моделі • Ovisno o modelu • Sõltuvalt mudelist • Atbilstoši modelim • Pagal modelį • بحسب الموديل • بر حسب مدل



| | Nb | | | |
|--------------|-----|-----------|--------------------|------------------------------|
| | | 600 g | 170°C | +/- 11-13 min |
| | | 1000 g | 190°C | +/- 14-16 min |
| | | 1200 g | 1 170°C 2 190°C | +/- 6-8 min +/- 10-12 min |
| | | 350/400 g | 190°C | +/- 6-7 min |
| | 8 | | 180°C | +/- 13-15 min |
| | 3 | | 170°C | +/- 6-8 min |
| | | 200 g | 150°C | +/- 8-10 min |
| | 7-8 | | 180°C | +/- 8-10 min |
| | 6 | | 180°C | +/- 6-8 min |
| * * * | Nb | | | |
| | | 750 g | 190°C | +/- 8-10 min |
| | | 450 g | 170°C | +/- 8-10 min |
| | 10 | | 190°C | +/- 6-8 min |
| | 8 | | 190°C | +/- 13-15 min |
| | | 900 g | 190°C | +/- 7-8 min |
| | | 300 g | 190°C | +/- 5-6 min |

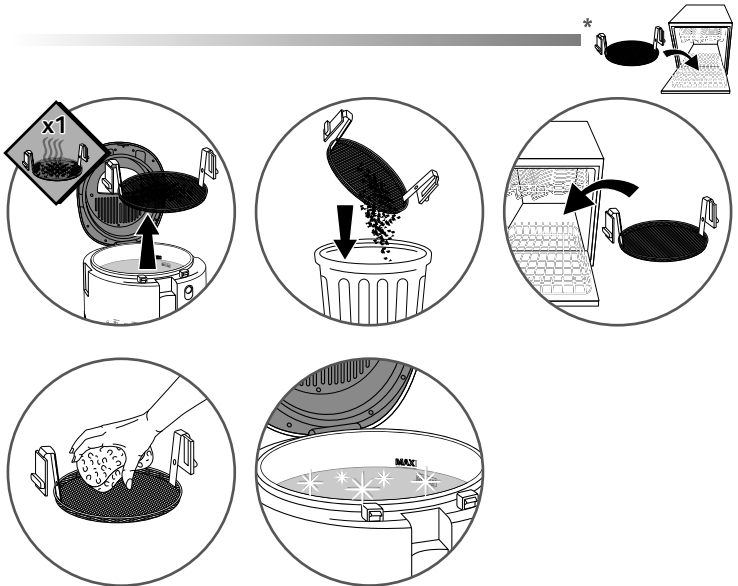

* Selon modèle • Afhankelijk van het model • Je nach Modell • Depending on model • Secondo i modelli • Según modelo • Consoante o modelo • ανάλογα με το μοντέλο • Modele göre • Afhængig af model • Beroende på modell • Avhenger av modell • Mallista riippuen • Ovisno o modelu • Zavisno od modela • В зависимости от модели • Odvisno od modela • W zależności od typu • Podle modelu • V závislosti od modelu • Modellitól függően • В зависимости от модели • Залежно від моделі • Ovisno o modelu • Sõltuvalt mudelist • Atbilstoši modelim • Pagal modelį • بحسب الموديل • بر حسب مدل

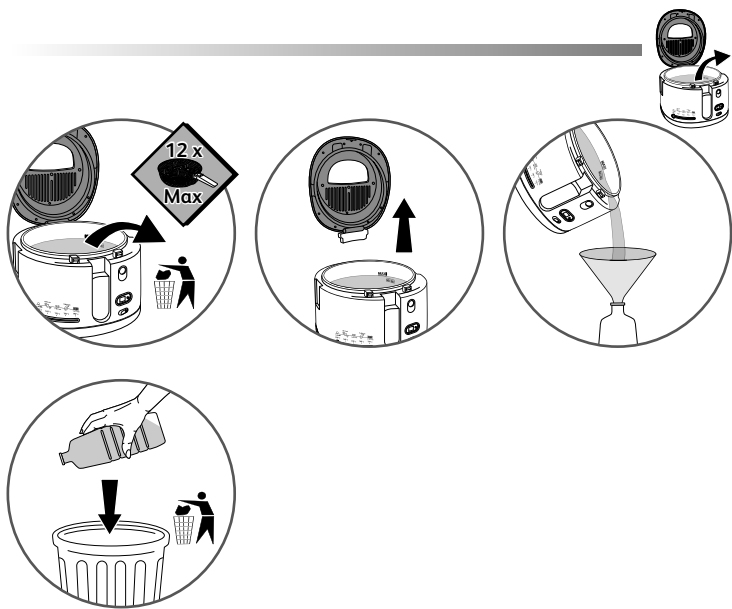

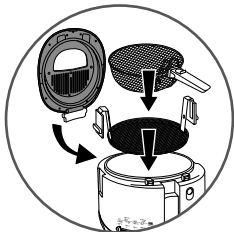
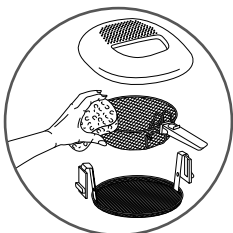
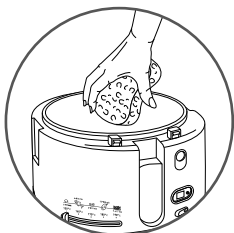
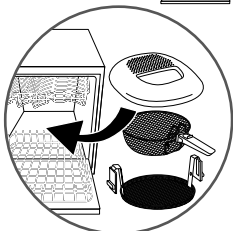
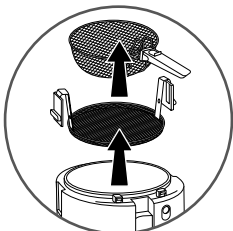
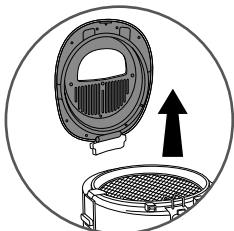

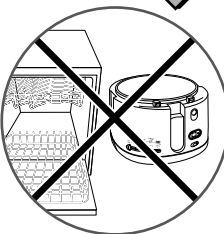

| TEFAL INTERNATIONAL GUARANTEE : COUNTRY LIST | | | |
|---|---|---|--|
|  |  |  |  |
| الجزائر ALGERIA | (0)41 28 18 53 | سنة واحدة 1 year | www.tefal-me.com |
| ARGENTINA | 0800-122-2732 | 2 años 2 years | GRUPE SEB ARGENTINA S.A. Billinghurst 1833 3° C1425DTK Capital Federal Buenos Aires |
| ՀԱՅԱՍՏԱՆ ARMENIA | (010) 55-76-07 | 2 տարի 2 years | ՓԲԸ "Գրուպա ՄԵԲ", 125171, Մոսկվա, Լենինգրադյան խճուղի, 16A, շին.3 |
| AUSTRALIA | 02 97487944 | 1 year | GRUPE SEB AUSTRALIA PO Box 7535, Silverwater NSW 2128 |
| ÖSTERREICH AUSTRIA | 01 890 3476 | 2 Jahre 2 years | SEB ÖSTERREICH GmbH Campus 21 - Businesspark Wien Süd, Liebermannstr. A02 702 2345 Brunn am Gebirge |
| نيرح بيلدا BAHRAIN | 17716666 | سنة واحدة 1 year | www.tefal-me.com |
| BANGLADESH | 8921937 | 1 year | www.tefal.com |
| БЕЛАРУСЬ BELARUS | 017 2239290 | 2 года 2 years | ЗАО «Группа СЕБ-Восток», 125171, Москва, Ленинградское шоссе, д. 16А, стр. 3 |
| BELGIQUE BELGIE BELGIUM | 070 23 31 59 | 2 ans 2 jaar 2 years | GRUPE SEB BELGIUM SA NV 25 avenue de l'Espérance - ZI 6220 Fleurus |
| BOSNA I HERCEGOVINA | Info-linija za potrošače 033 551 220 | 2 godine 2 years | SEB Développement Predstavništvo u BiH Vrazova 8/II 71000 Sarajevo |
| BRASIL BRAZIL | 11 2915-4400 | 1 ano 1 year | SEB COMERCIAL DE PRODUTOS DOMÉSTICOS LTDA Rua Venâncio Aires, 433, Pompéia, São Paulo/SP |
| БЪЛГАРИЯ BULGARIA | 0700 10 330 | 2 години 2 years | ГРУП СЕБ БЪЛГАРИЯ ЕООД бул. България 81 В, ет. 5 1404 София |
| CANADA | 1-800-418-3325 | 1 an 1 year | GRUPE SEB CANADA 345 Passmore Avenue Toronto, ON, M1V 3N8 |
| CHILE | 12300 209207 | 2 años 2 years | GRUPE SEB CHILE Comercial Ltda Av. Providencia, 2331, Piso 5, Oficina 501 Santiago |

| | | | |
|--|---------------------------|---------------------|---|
| COLOMBIA | 18000919288 | 2 años 2 years | GRUPE SEB COLOMBIA Apartado Aereo 172, Kilometro 1 Via Zipaquira, Cajica Cundinamarca |
| HRVATSKA CROATIA | 01 30 15 294 | 2 godine 2 years | SEB mku & p d.o.o. Vodnjanska 26, 10000 Zagreb |
| ČESKÁ REPUBLIK CZECH REPUBLIC | 731 010 111 | 2 roky 2 years | Groupe SEB CR s.r.o. Futurama Business Park (budova A) Sokolovská 651/136a 186 00 Praha 8 |
| DANMARK DENMARK | 44 663 155 | 2 år 2 years | GRUPE SEB NORDIC AS Tempovej 27, 2750 Ballerup |
| EESTI ESTONIA | 668 1286 | 2 aastat 2 years | GRUPE SEB POLSKA Sp. z o.o. ul. Bukowińska 22b 02-703 Warszawa |
| مصر EGYPT | الخط الساخن: 16622 | سنة واحدة 1 year | جروب سب ايجيبت طريق 14 مايو - سموحة الإسكندرية - مصر |
| SUOMI FINLAND | 09 622 94 20 | 2 vuotta 2 years | Groupe SEB Finland Kutojantie 7, 02630 Espoo |
| FRANCE Continentale + Guadeloupe, Martinique, Réunion, Saint-Martin | 09 74 50 47 74 | 1 an 1 year | GRUPE SEB France Service Consommateur Tefal 112 Ch. Moulin Carron, TSA 92002 69134 ECULLY Cedex |
| DEUTSCHLAND GERMANY | 0212 387 400 | 2 Jahre 2 years | GRUPE SEB DEUTSCHLAND GmbH / KRUPS GmbH Herrnrainweg 5, 63067 Offenbach |
| ΕΛΛΑΔΑ GREECE | 2106371251 | 2 χρόνια 2 years | SEB GROUPE ΕΛΛΑΔΟΣ Α.Ε. Οδός Καβαλιεράτου 7 Τ.Κ. 145 64 Κ. Κηφισιά |
| 香港 HONG KONG | 8130 8998 | 1 year | SEB ASIA Ltd. Room 903, 9/F, South Block, Skyway House 3 Sham Mong Road, Tai Kok Tsui, Kowloon, Hong-Kong |
| MAGYARORSZÁG HUNGARY | 06 1 801 8434 | 2 év 2 years | GRUPE SEB CENTRAL EUROPE Kft. Táviró köz 4 2040 Budaörs |
| INDONESIA | +62 21 5793 6881 | 1 year | GRUPE SEB INDONESIA (Representative office) Sudirman Plaza, Plaza Marein 8th Floor JL Jendral Sudirman Kav 76-78, Jakarta 12910, Indonesia |
| ITALIA ITALY | 199207354 | 2 anni 2 years | GRUPE SEB ITALIA S.p.A. Via Montefeltro, 4 20156 Milano |
| 日本 JAPAN | 0570 077 772 | 1 year | 株式会社グループセブジャパン 〒144-0042 東京都大田区羽田旭町 11-1 羽田クロノゲート事務棟 5F |
| نادرأا JORDAN | 5665505 | سنة واحدة 1 year | www.tefal-me.com |

| | | | |
|--------------------------------------|-------------------------|---------------------|---|
| ҚАЗАҚСТАН KAZAKHSTAN | 727 378 39 39 | 2 жыл 2 years | ЖАҚ «Группа СЕБ- Восток» 125171, Мәскеу, Ленинградское шоссесі,16А, 3 үйі |
| 한국어 KOREA | 1588-1588 | 1 year | (유)그룹 세브 코리아 서울시 종로구 청계천로 35 서린빌딩 2층 110-790 |
| تيلوكل KUWAIT | 24831000 | سنة واحدة 1 year | www.tefal-me.com |
| LATVJA LATVIA | 6 616 3403 | 2 gadi 2 years | GROUPE SEB POLSKA Sp. z o.o. ul. Bukowińska 22b, 02-703 Warszawa |
| لبنان LEBANON | 4414727 | سنة واحدة 1 year | www.tefal-me.com |
| LIETUVA LITHUANIA | 5 214 0057 | 2 metai 2 years | GROUPE SEB POLSKA Sp. z o.o. ul. Bukowińska 22b, 02-703 Warszawa |
| LUXEMBOURG | 0032 70 23 31 59 | 2 ans 2 years | GROUPE SEB BELGIUM SA NV 25 avenue de l'Espérance - ZI 6220 Fleurus |
| МАКЕДОНИЈА MACEDONIA | (02) 20 50 319 | 2 години 2 years | Групе СЕБ Бугарија ЕООД Office 1, floor 1, 52G Borovo St., 1680 Sofia - Bulgaria ГРУП СЕБ БЪЛГАРИЈА ДООЕЛ Ул. Борово 52 Г, сп. 1, офис 1, 1680 София, България |
| MALAYSIA | 603-7710 8000 | 2 years | GROUPE SEB MALAYSIA SDN. BHD Unit No. 402-403, Level 4, Uptown 2, No. 2, Jalan SS21/37, Damansara Uptown, 47400, Petaling Jaya, Selangor D.E. Malaysia |
| MEXICO | (01800) 112 8325 | 1 año 1 year | Groupe S.E.B. México, S.A. DE C.V. Goldsmith 38 Desp. 401, Col. Polanco Delegación Miguel Hildalgo 11 560 México D.F. |
| MOLDOVA | (22) 929249 | 2 ani 2 years | ТОВ «Груп СЕБ Україна» 02121, Харківське шосе, 201-203, 3 поверх, Київ, Україна |
| NEDERLAND The Netherlands | 0318 58 24 24 | 2 jaar 2 years | GROUPE SEB NEDERLAND B.V. De Schutterij 27 3905 PK Veenendaal |
| NEW ZEALAND | 0800 700 711 | 1 year | GROUPE SEB NEW ZEALAND Unit E, Building 3, 195 Main Highway, Eilerslie, Auckland |
| NORGE NORWAY | 815 09 567 | 2 år 2 years | GROUPE SEB NORDIC AS Tempovej 27 2750 Ballerup |

| | | | |
|--|---|---------------------|---|
| قنظلس عُمان OMAN | 24703471 | سنة واحدة 1 year | www.tefal-me.com |
| PERU | 441 4455 | 1 año 1 year | Groupe SEB Perú Av. Camino Real N° 111 of. 805 B San Isidro - Lima |
| POLSKA POLAND | 801 300 420 koszt jak za połączenie lokalne | 2 lata 2 years | GROUPE SEB POLSKA Sp. z o.o. ul. Bukowińska 22b, 02-703 Warszawa |
| PORTUGAL | 808 284 735 | 2 anos 2 years | GROUPE SEB IBÉRICA SA Urb. da Matinha Rua Projectada à Rua 3 Bloco1 - 3° B/D 1950 - 327 Lisboa |
| رطق QATAR | 4448-5555 | سنة واحدة 1 year | www.tefal-me.com |
| REPUBLIC OF IRELAND | 01 677 4003 | 1 year | GROUPE SEB IRELAND Unit B3 Aerodrome Business Park, College Road, Rathcoole, Co. Dublin |
| ROMÂNIA ROMANIA | 0 21 316 87 84 | 2 ani 2 years | GROUPE SEB ROMÂNIA Str. Daniel Constantin nr. 8 010632 București |
| РОССИЯ RUSSIA | 495 213 32 30 | 2 года 2 years | ЗАО «Группа СЕБ-Восток», 125171, Москва, Ленинградское шоссе, д. 16А, стр. 3 |
| تلفلجلا ةيبرعلا ةيدوعسلا SAUDI ARABIA | 920023701 | سنة واحدة 1 year | www.tefal-me.com |
| SRBIJA SERBIA | 060 0 732 000 | 2 godine 2 years | SEB Développement Đorđa Stanojevića 11b 11070 Novi Beograd |
| SINGAPORE | 6550 8900 | 1 year | GROUPE SEB SINGAPORE Pte Ltd. 59 Jalan Peminpin, #04-01/02 L&Y Building, Singapore 577218 |
| SLOVENSKO SLOVAKIA | 233 595 224 | 2 roky 2 years | GROUPE SEB Slovensko, spol. s r.o. Cesta na Senec 2/A 821 04 Bratislava |
| SLOVENIJA SLOVENIA | 02 234 94 90 | 2 leti 2 years | SEB d.o.o. Gregorčičeva ulica 6 2000 MARIBOR |
| SOUTH AFRICA | 0100202222 | 1 year | GS South Africa Building 17, PO BOX 107 The Woodlands Office Park, 20 Woodlands Drive, Woodmead 2080 |
| ESPAÑA SPAIN | 902 31 24 00 | 2 años 2 years | GROUPE SEB IBÉRICA S.A. C/ Almogàvers, 119-123, Complejo Ecourban, 08018 Barcelona |
| SRI LANKA | 115400400 | 1 year | www.tefal-me.com |
| SVERIGE SWEDEN | 08 594 213 30 | 2 år 2 years | TEFAL SVERIGE SUBSIDIARY OF GROUPE SEB NORDIC Truckvägen 14 A, 194 52 Upplands Väsby |

| | | | |
|---|----------------------|-----------------------------|---|
| SUISSE SCHWEIZ SWITZERLAND | 044 837 18 40 | 2 ans 2 Jahre 2 years | GRUPE SEB SCHWEIZ GmbH Thurgauerstrasse 105 8152 Glattbrugg |
| ประเทศไทย THAILAND | 02 769 7477 | 2 years | GRUPE SEB THAILAND 2034/66 Italthai Tower, 14th Floor, n° 14-02, New Phetchburi Road, Bangkok, Huaykwang, Bangkok, 10320 |
| TÜRKIYE TURKEY | 216 444 40 50 | 2 YIL 2 years | GRUPE SEB ISTANBUL AS Beybi Giz Plaza Dereboyu Cad. Meydan Sok., No: 28 K.12 Maslak |
| شماره اال دبي برع ال قدحتملا UAE | 8002272 | سنة واحدة 1 year | www.tefal-me.com |
| U.S.A. | 800-395-8325 | 1 year | GRUPE SEB USA 2121 Eden Road, Millville, NJ 08332 |
| Україна UKRAINE | 044 300 13 04 | 2 роки 2 years | ТОВ «Груп СЕБ Україна» 02121, Харківське шосе, 201-203, 3 поверх, Київ, Україна |
| UNITED KINGDOM | 0845 602 1454 | 1 year | GRUPE SEB UK LTD Riverside House, Riverside Walk Windsor, Berkshire, SL4 1NA |
| VENEZUELA | 0800-7268724 | 2 años 2 years | GRUPE SEB VENEZUELA Av Eugenio Mendoza, Centro Letonia, Torre ING Bank, Piso 15, Ofc 155 Urb. La Castellana, Caracas |
| VIETNAM | 08 38645830 | 2 năm 2 years | Vietnam Fan Joint Stock Company 25 Nguyen Thi Nho Str, Ward 9, Tan Binh Dist, HCM city |
| نم يلا YEMEN | 1264096 | سنة واحدة 1 year | www.tefal-me.com |

Réf. NC00123816 • 03/2014 • Subject to modifications
ESPACE GRAPHIQUE