



Thank you for purchasing an Onkyo product. Please read this manual thoroughly before making connections and plugging in your new Onkyo product. Following the instructions in this manual will enable you to obtain optimum performance and listening enjoyment from your new product. Please retain this manual for future reference.

Trademarks and Licensing

DOLBY DIGITAL Manufactured under license from Dolby Laboratories. Dolby and the double-D symbol are trademarks of Dolby Laboratories.

Bluetooth The Bluetooth® word mark and logos are registered trademarks owned by Bluetooth SIG, Inc. and any use of such marks by Onkyo is under license. Other trademarks and trade names are those of their respective owners.

AURASPHERE AuraSphere™ is a trademark of Onkyo Corporation.

AuraSphere is a listening experience technology developed by Onkyo Corporation and Sonic Emotion ag.



PACKAGE CONTENTS

Make sure you have the following items before use.

- The number in parenthesis indicates the quantity.
- In catalogs and on packaging, the letter at the end of the product name indicates the color.

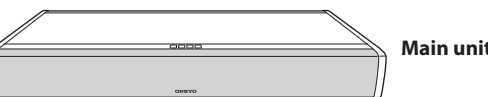

Main unit (1)



AC adapter (1)/
Power cord (1)



Remote controller (RC-8775) (1)
A lithium-ion battery (CR2025) is supplied in the remote control at the time of purchase.



Optical digital audio cable 5 ft. (1.5 m) (1)



φ3.5 mm stereo mini plug cable (1)

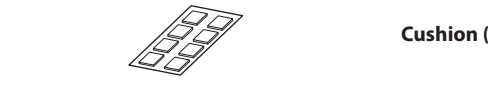

Cushion (8)

PREPARATION

Placement

Select an appropriate placement for your environment.

- To enjoy the best sound, do not place an object on both sides of the unit. Furthermore, mount this unit carefully since the subwoofer unit is housed on its bottom face.
- Mount this unit on a firm surface such as a low board.

Mounting under TV

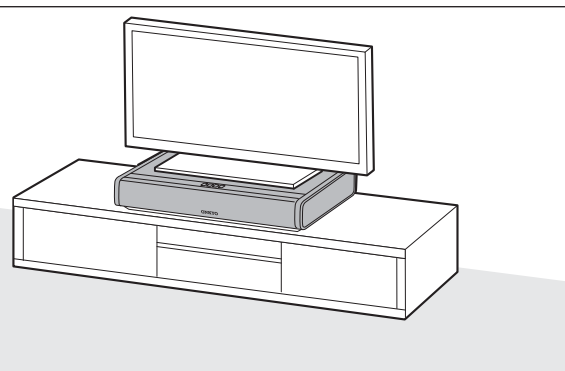

Accessories to be prepared: Cushion
To prevent vibration, mount this unit after attaching the supplied cushions to the feet of the TV stand. Using the supplied cushions will allow you to limit the effect of vibrations on the TV.

1. Attach the supplied cushions to the feet of the TV stand.

- Be very careful when attaching the cushions. Depending on the size and weight of the TV in particular, be sure to have at least two people do the job to prevent injury.
- Wrap the TV with a blanket or soft cloth to not scratch it and work carefully.
- When the supplied cushions and the feet of the TV do not match, cut and shape the cushions for use as needed.

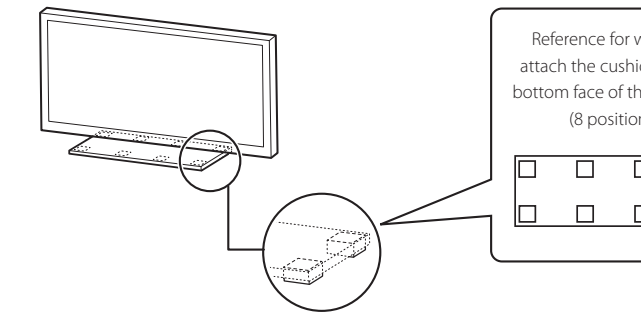

Reference for where to attach the cushion on the bottom face of the TV stand (8 positions).

2. Mount the unit.

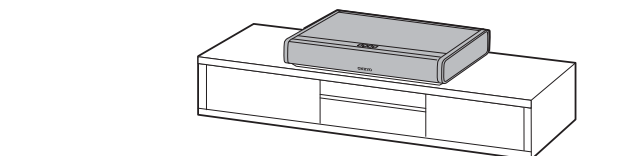

3. Connect all cables to the unit.

(→ See 7 to 8 pages)

4. Mount the TV on the center of the top face of this unit.

- Mount the unit correctly by referring to the figure below.

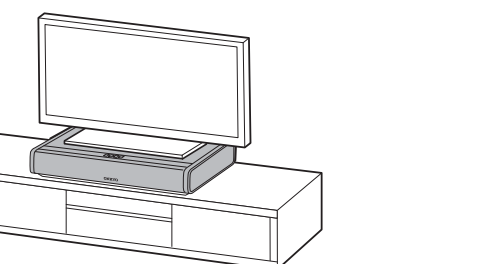

Mountable range of the TV Stand

- Adjust the TV stand position within the shaded area.
- Place the TV stand in such a way that its center matches that of this unit.

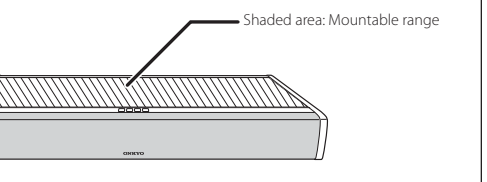

Precautions for mounting this unit under TV

- TVs that can be placed on top of this unit are those having a mass of 77 lbs (35 kg) or less, stand width of 26 1/2" (674 mm) or less, and depth of 10 3/8" (265 mm) or less.
- By referring to the figure on the left, mount the TV on the center of the mountable range. If the TV protrudes from any of the mountable range, the TV may tip over and cause injury.

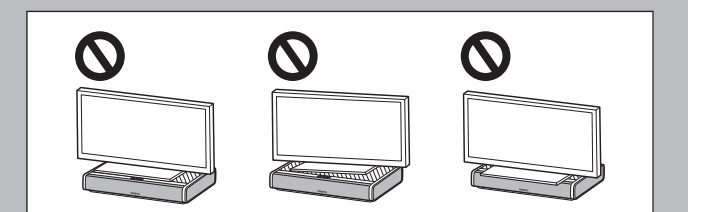

- For TV tip-over/fall prevention measures, see the TV owner's manual.
- Onkyo is not responsible for accidents or damage caused by improper installation, improper cushion attachment, improper use or natural calamity, etc.

Connections

- Connect the TV and this unit using one of the possible connection cables.

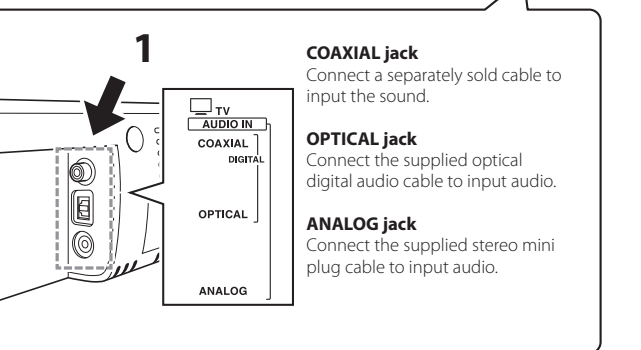
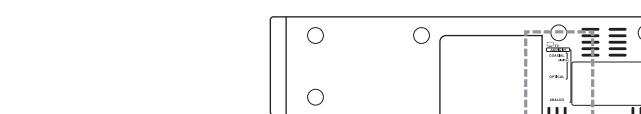
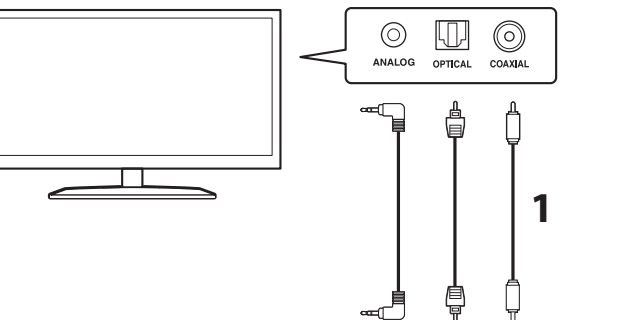

COAXIAL jack
Connect a separately sold cable to input the sound.

OPTICAL jack
Connect the supplied optical digital audio cable to input audio.

ANALOG jack
Connect the supplied stereo mini plug cable to input audio.

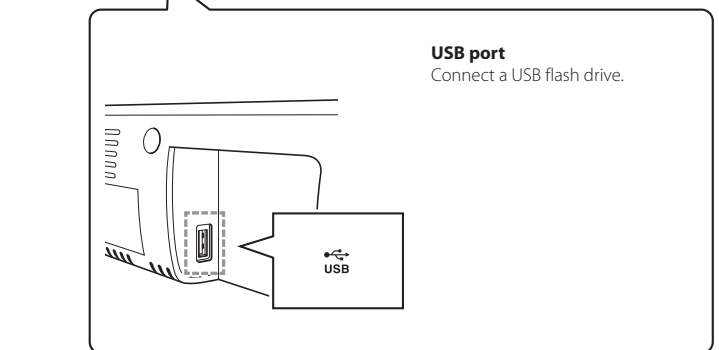
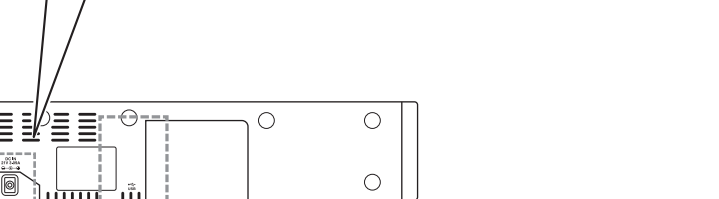
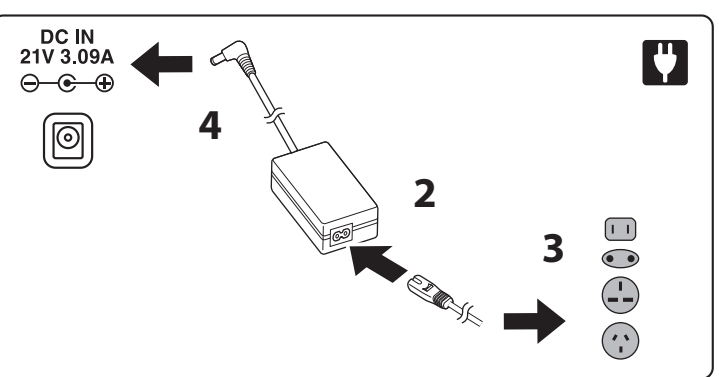

USB port
Connect a USB flash drive.

Listening to TV

Turn on the TV.

- For details on operation, see the "BASIC OPERATION" (→ P.11).
- The unit can be operated with your existing TV remote controller. For details on operation, see the "Using TV Remote Controller" (→ P.17).

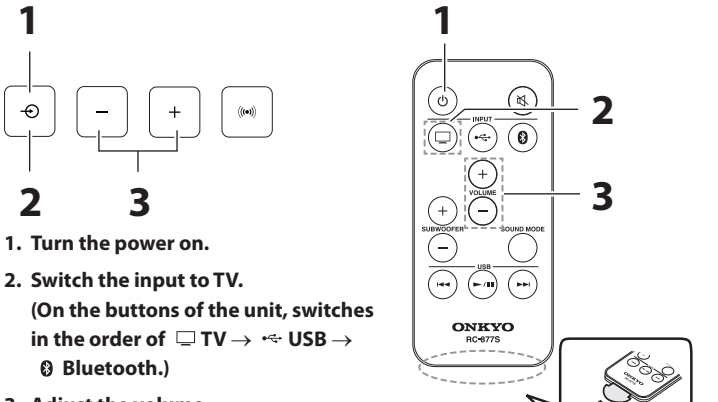

1. Turn the power on.
2. Switch the input to TV. (On the buttons of the unit, switches in the order of TV → USB → Bluetooth.)
3. Adjust the volume.

Onkyo Corporation
Kitahama Chuo Bldg, 2-2-22 Kitahama, Chuo-ku, OSAKA 541-0041, JAPAN
<http://www.onkyo.com/>

The Americas
Onkyo U.S.A. Corporation
18 Park Way, Upper Saddle River, N.J. 07458, U.S.A.
For Dealer, Service, Order and all other Business Inquiries:
Tel: 201-785-2600 Fax: 201-785-2650
<http://www.us.onkyo.com/>

For Product Support Team Only:
1-800-229-1687
<http://www.us.onkyo.com/>

Europe
Onkyo Europe Electronics GmbH
Liegnitzerstrasse 6, 82194 Groebenzell, GERMANY
Tel: +49-8142-4401-0 Fax: +49-8142-4208-213
<http://www.eu.onkyo.com/>

Onkyo Europe Electronics GmbH (UK Branch)
Meriden House, Ground floor, 69 - 71 Clarendon Road, Watford, Hertfordshire, WD17 1DS, United Kingdom
Tel: +44 (0)8712-00-19-96 Fax: +44 (0)8712-00-19-95

China
Onkyo China Limited (Hong Kong)
Unit 1033, 10/F, Star House, No 3, Salisbury Road, Tsim Sha Tsui Kowloon, Hong Kong.
Tel: 852-2429-3118 Fax: 852-2428-9039
<http://www.hk.onkyo.com/>

Onkyo China PRC (Mainland)
1301, 555 Tower, No.555 West NanJing Road, Jing'an District, Shanghai, China 200041.
Tel: 86-21-52131366 Fax: 86-21-52130396
<http://www.cn.onkyo.com/>

Asia, Oceania, Middle East, Africa
Please contact an Onkyo distributor referring to Onkyo SUPPORT site.
<http://www.intl.onkyo.com/support/>

The above-mentioned information is subject to change without prior notice. Visit the Onkyo web site for the latest update.

BASIC OPERATION

Using Main Unit Controls

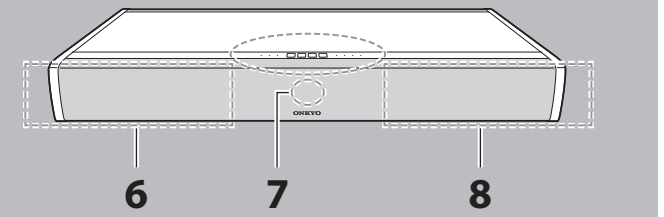
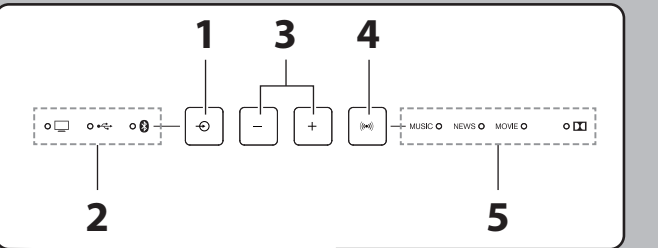

Regarding the buttons on the main unit: The buttons on this unit are touch sensitive switches. Therefore, they may respond poorly depending on how they are pressed or not respond when pressed fast and consecutively.

1. (ON/STANDBY) button/INPUT button

Switches the power on/standby. Also, switches the input source.

- **To turn the power on:** Press once when this unit is turned off.
- **To turn the standby:** Press and hold for 3 seconds. The indicators go off.
- **To input the source:** Press once to switch. Switches in the order of TV → USB → Bluetooth each time the button is pressed.

- **Auto Power On function:** The unit automatically turns on when audio signal is output from the TV. To switch on/off this function, press and hold first (ON/STANDBY) button, and then (MUTE) (+) for about 3 seconds. When this function is set to on, the (MUTE) indicator flashes once. It flashes twice when this function is set to off.
- **Auto Standby function:** The unit automatically enters the standby mode if the status with no operation and sound continues 5 minutes. To switch on/off this function, press and hold first (ON/STANDBY) button, and then (MUTE) (-) for about 3 seconds. When this function is set to on, the (MUTE) indicator flashes once. It flashes twice when this function is set to off.

2. INPUT source indicators

- (TV) Lights when the source is TV.
- (USB) Lights when the source is USB.
- (Bluetooth) Lights when the source is Bluetooth.

3. (-) (+) VOLUME +/- buttons

Allows to adjust the volume by 1 step in the 0 to 30 range.

- Pressing the (-) (+) buttons together will mute audio. The status indicator on the front of the main unit will flash. Press the VOLUME +/- button again to cancel mute.

4. (MUSIC) SOUND MODE button

Switches the sound mode of input sound as desired. The mode switches in the order of MUSIC → NEWS → MOVIE → MUSIC → each time the button is pressed. You can select the mode for each input source (TV, USB and Bluetooth).

- **MUSIC Mode:** Gives concert hall-like sound effect.
- **NEWS Mode:** Allows to comfortably listen news programs.
- **MOVIE Mode:** Creates powerful 3D sound effect suitable for enjoying movies.

5. SOUND MODE indicators

- Lights according to the selected sound mode.
- MUSIC Lights in the music mode.
 - NEWS Lights in the news mode.
 - MOVIE Lights in the movie mode.
 - (Dolby Digital) Lights when the input signal is Dolby Digital.

6. Left channel speaker

7. Status indicator

Lights white when the power is on. It keeps flashing during mute. It flashes just once every time volume is adjusted or the input or sound mode is changed. It goes off during standby.

8. Right channel speaker

Using Remote Controller

How to Use Remote Controller

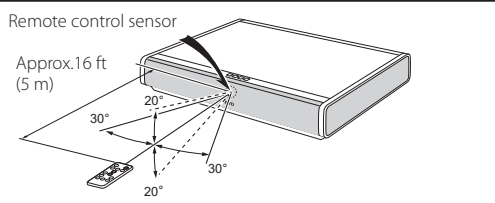

How to Replace Remote Controller Battery

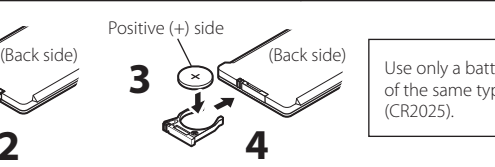

Use only a battery of the same type (CR2025).

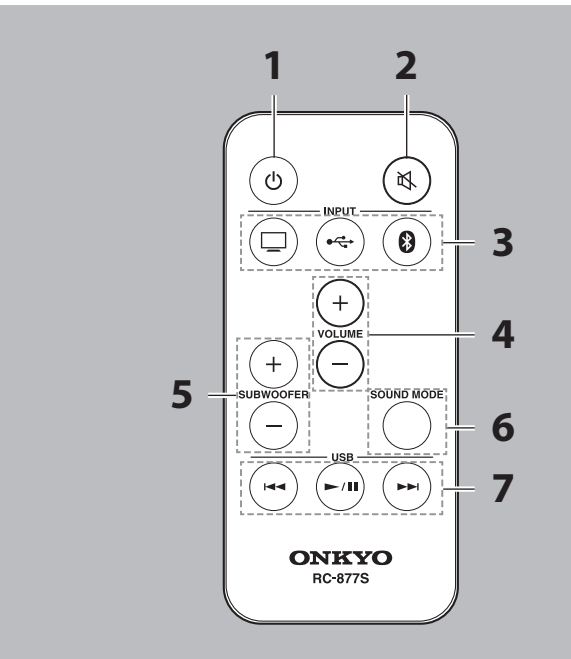

1. (ON/STANDBY) button

Switches the power on/standby.

2. (Mute) button

Turns the audio off temporarily. Press again to cancel muting.

- The Status indicator flashes when the audio is muted.
- Muting will also be canceled when the volume is changed or the power is turned off and on.

3. INPUT buttons

Switches the input source.

- **To play the TV sound:** Turns the TV on and press the (TV) button.
- **To play music from a USB flash drive:** Connect the USB flash drive and press the (USB) button.
- **To play music from a Bluetooth device:** Press the (Bluetooth) button. Refer to page 16 for connecting.

4. VOLUME +/- buttons

Allows to adjust the volume by 1 step in the 0 to 30 range.

5. SUBWOOFER +/- button

Allows to adjust the subwoofer level by 1 step in the -10 to +10 range while listening to the sound. The default setting is 0.

6. SOUND MODE button

Switches the sound mode of input sound as desired. The mode switches in the order of MUSIC → NEWS → MOVIE → MUSIC → each time the button is pressed. You can select the mode for each input source (TV, USB and Bluetooth).

- **MUSIC Mode:** Gives concert hall-like sound effect.
- **NEWS Mode:** Allows to comfortably listen news programs.
- **MOVIE Mode:** Creates powerful 3D sound effect suitable for enjoying movies.

7. USB operation buttons

Allows operation when the input source is USB.

- (Previous) button: Pressing once returns the audio to the beginning of the file being played. Pressing twice continuously returns it to the previous file. Then the audio will skip back to the previous file each time the button is pressed.
- (Play/Pause) button: Pressing during stop starts playback. Pressing during playback temporarily stops the audio.
- (Next) button: The audio skips to the next file each time the button is pressed.

Playing via Bluetooth Connection

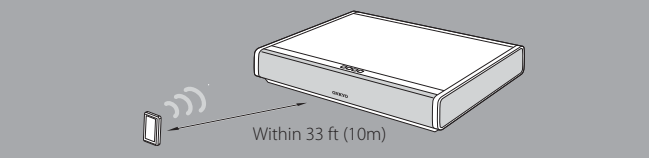

1. Turn the unit on.

2. Press (Bluetooth) .

- The (Bluetooth) indicator flashes faster, and the pairing starts.
- The pairing will end in about 30 seconds and the indicator starts flashing slowly.

3. On the Bluetooth device, select the unit (Onkyo LS-T10) to make a connection.

- For details on operation, see the instruction manual of the Bluetooth device.
- If the operation does not start as normal within the 33 feet (10 m) range, get the Bluetooth device closer to the unit and retry the operation.

- If a passcode (password, passkey or PIN code) is requested, enter "0000".
- When the pairing is completed, the (Bluetooth) indicator lights.

4. Start playback.

- If you reset Bluetooth of this unit or removed the registration of this unit from the Bluetooth device, perform pairing (see above) again.
- To connect any other Bluetooth device, press and hold the (Bluetooth) button of the main unit to start pairing.

Steps 3 and 4 need to be performed on the Bluetooth device.

Using TV Remote Controller

● **Preprogrammed functions:** This unit has been preprogrammed so that it can be operated with your existing TV remote controller. The functions that can be operated are volume control (+/-) and muting (MUTE). If you want to use other functions or cannot operate with your TV remote controller, you can learn the learning function as below to enable the operation.

- The mute state can be turned over each time you press the Mute button on your TV remote controller. In such case, you can synchronize the mute status of the unit and the TV by pressing and holding the Mute button on your TV remote controller.
- To disable the preprogrammed function, press and hold first (ON/STANDBY) and then (MUTE) for about 10 seconds. When the preprogrammed function is successfully disabled, (MUTE) indicator flashes 3 times, then any TV remote controller cannot be used to operate the unit. When you want to re-enable the preprogrammed function, perform the same operation. When the preprogrammed function is successfully re-enabled, (MUTE) indicator flashes once, then you can use any remote controller using preprogrammed function.

To control the preprogrammed functions: Varieties of TV remote controllers have been preprogrammed on this unit, which may lead to unintended operation from the other remote controller than your TV remote controller. In such case, press and hold first (ON/STANDBY) and then (MUTE) and then press either volume or mute button on your TV remote controller 2 or 3 times to turn on the controlling function. When the controlling function is set to on, the (MUTE) indicator flashes twice, and then, the other remote controller cannot be operated.

- Controlling function may not be set to some TV remote controllers.
- To cancel the controlling function, press and hold first (ON/STANDBY) and then (MUTE) for about 10 seconds. When the controlling function is successfully cancelled, (MUTE) indicator flashes once, then you can use any remote controller using preprogrammed function.

● Learning function:

You can operate the unit with a TV remote controller by assigning the functions to the buttons of the remote controller. Perform the following button operation, when the (MUTE) indicator starts flashing, direct your TV remote controller to remote control sensor of this unit and press the button to assign on the TV remote controller 3 times. When the Learning function is successfully set, (MUTE) indicator flashes twice.

* Press (MUTE) button first when pressing and holding the buttons together.

Learning function	Button operation (Press simultaneously for 3 seconds)
ON/STANDBY	(MUTE) → (ON/STANDBY)
VOLUME +	(MUTE) → (+)
VOLUME -	(MUTE) → (-)

Learning function	Button operation (Press simultaneously for 3 seconds)
MUTE	(MUTE) → (+) + (-)
INPUT	(MUTE) → (TV) + (+)
SOUND MODE	(MUTE) → (MUSIC) + (-)

- It is recommended to select buttons that do not prevent TV operation when assigning the functions to your remote controller.
- Signal of some types of remote controller may not be received by the unit. In that case, use the remote controller supplied with the unit.

Troubleshooting

Check the items below if you have any problem.

Before requesting repair: If the unit does not work or accept control, try resetting the unit to its factory defaults and check if your problem is solved. Perform the following reset procedure.

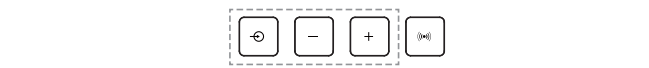

1. Press and hold the (ON/STANDBY) button on the main unit and the (-) (+) buttons for 10 seconds.

When reset is complete, the three INPUT source indicators flash and the unit automatically enters the standby mode.

Power

Can't turn on the unit

- Make sure that the power cord is properly plugged into the wall outlet. (→P8)
- Unplug the power cord from the wall outlet, wait 10 seconds or more, then plug it in again.

The unit turns off unexpectedly

- The unit will automatically enter standby mode when Auto Standby launches. (→P.12)

The unit turns off and after restoring the power, it turns off again

- The protection circuit has been activated. Remove the power cord from the wall outlet immediately. Make sure that all cables and input sources are properly connected, and leave the unit with its power cord disconnected for 1 hour. After that, reconnect the power cord and turn the power on. If the unit turns off again, unplug the power cord and contact your Onkyo dealer.

If smoke, smell or abnormal noise is produced by the unit, unplug the power cord from the wall outlet immediately and contact your Onkyo dealer.

Audio

There's no sound, or it's very quiet

- Make sure that all audio connecting plugs are pushed in all the way. (→P.7, 8)
- Make sure that the input of device is connected properly. (→P.7, 8)
- When the Status indicator flashes in white, the muting is enabled. Press (MUTE) or Volume +/- on the remote controller or the Volume +/- buttons simultaneously on the unit to disable the muting. (→P.14)

- Make sure that none of the connecting cables are bent, twisted, or damaged.

The base sound cannot be heard

- The protection circuit in the subwoofer may have tripped due to a rise in temperature. Disconnect the power cord from the outlet and reconnect after a while.

Noise can be heard

- Do not bind the power cord, connection cables and other audio cables with a band.
- An audio cable may be picking up interference. Try repositioning your cables.
- Make sure that there is no obstacle or reflection between the unit and the subwoofer.

Remote Controller

The remote controller doesn't work

- Make sure that the battery is installed with the correct polarity. (→P.13)
- Make sure that the remote controller is not too far away from the unit, and that there's no obstruction between the remote controller and the unit's remote control sensor. (→P.13)
- Make sure that the unit is not subjected to direct sunshine or invertertype fluorescent lights. Relocate if necessary.

Playing USB Memory

The unit supports USB memory formatted using FAT12, FAT16 and FAT32 file system.

- The unit is compatible with MP3 playback and following audio format is supported.
 - MPEG1 Audio Layer3 format with a sampling rate of 32, 44.1 or 48 kHz and 32 to 320 kbps bit rate
 - MPEG2 Audio Layer3 format with a sampling rate of 16, 22.05 or 24 kHz and 8 to 160 kbps bit rate
 - MPEG2.5 Audio Layer3 format with a sampling rate of 8, 11.025 or 12 kHz and 8 to 64 kbps bit rate

- You can play MP3 files stored on the root folder only. MP3 files stored on the other folders cannot be played on this unit.

- The unit supports USB flash drives only. Note, however, that playback may not be possible with some USB flash drives.

The unit contains a microcomputer for signal processing and control functions. In very rare situations, severe interference, noise from an external source, or static electricity may cause it to lockup. In the unlikely event that this happens, unplug the power cord from the wall outlet, wait at least five seconds, and then plug it back in.

If it doesn't work properly, please try resetting (→P.18).

Onkyo is not responsible for damages (such as CD rental fees) due to unsuccessful recordings caused by the unit's malfunction. Before you record important data, make sure that the material will be recorded correctly.