

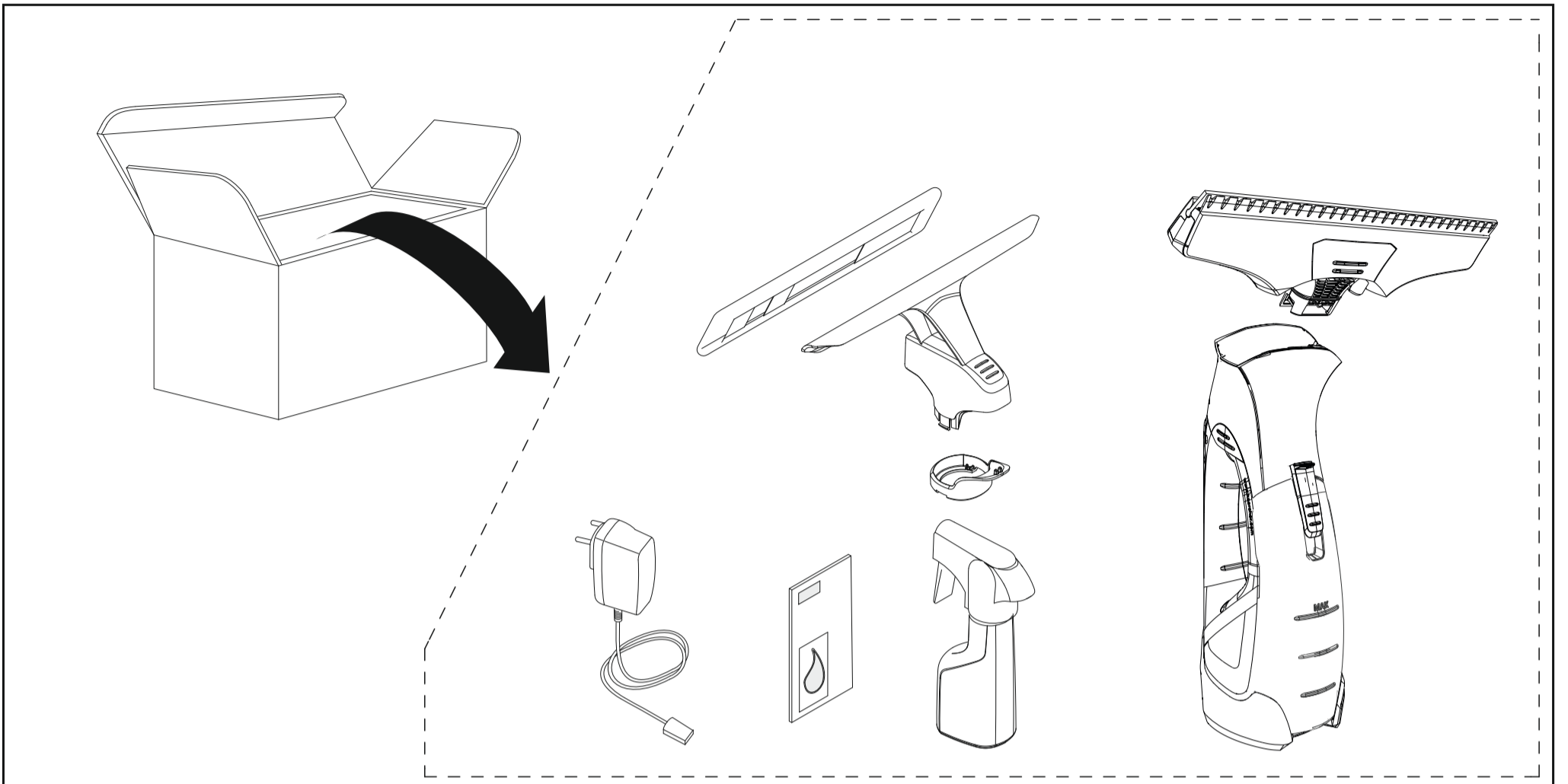

59664910 (02/15)

# WV 5 Plus

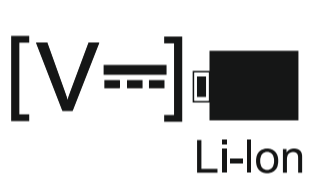

 Li-Ion	3,7 V		IP X4		0,70 kg
 nom	10 W		100 ml		210 min
	V 5,5 mA 600		50 db(A)		35 min

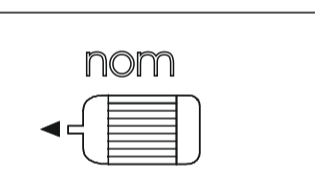
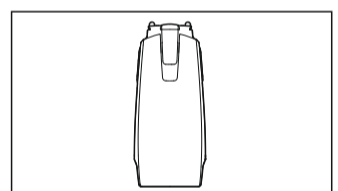
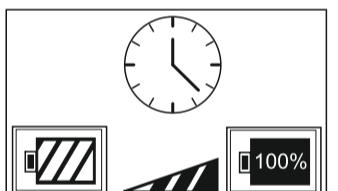
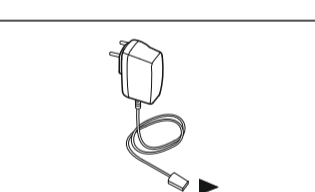
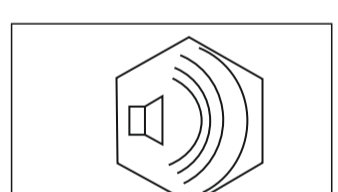
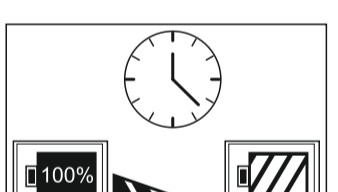